

New-Tronics Ltd.



*“Beyond Your Expectations”*

**CB, SCANNER ANTENNAS  
and Accessories**

**CATALOG  
062917**

**TOLL FREE ORDER LINE: (877) 994-9499  
(940) 325-1386 FAX (940) 328-1409  
[www.new-tronics.com](http://www.new-tronics.com)  
email: [sales@new-tronics.com](mailto:sales@new-tronics.com)**

**New-Tronics Ltd.  
One Newtronics Place  
Mineral Wells, Texas 76067**

**PRICES SUBJECT TO CHANGE WITHOUT NOTICE**

# TRUCKER CENTER LOAD

Designed to meet the most demanding trucking application, the SCB sets new standards in electrical performance as well as durability. Heavy chrome plated parts to enhance the look of your rig.

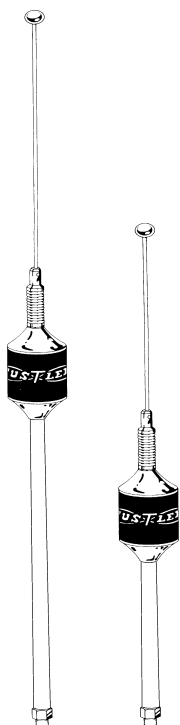

- Frequency Range 26 – 30 MHz
- Computer designed coil capable of covering 120 channels
- ¼ wavelength design
- 1.6 MHz bandwidth
- Adjustable whip length for accurate tuning
- Chrome plated top and bottom caps
- Shock absorption stainless steel spring to prevent breakage
- Stainless steel 17-7 ph whip
- Dissipation tip to eliminate static build up
- Solid 3/8 inch diameter stainless steel lower rod
- Used as a single antenna or co-phased for dual application
- Available in your choice of black, white, red or blue coils to match your rig
- Mates with 3/8 x 24 threaded mounts

## SCB

55 inches overall length. 22" lower shaft to elevate coil for better radiation pattern

## SCB-S

45 inches overall length. 9" lower shaft. Weather band reception

SCB SCB-S

# FIBERGLASS ANTENNAS

Wound around a heavy duty 3/8 inch diameter fiberglass core. Hustler fiberglass sticks are rugged, high performance antennas. The large diameter fiberglass core resists damage and will easily handle high power needs.

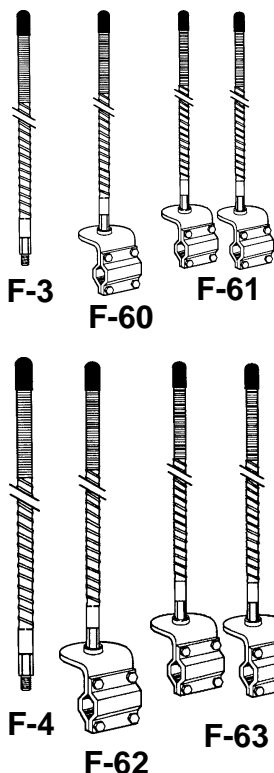

- Heavy duty 3/8 inch fiberglass rod
- Factory tuned whips
- ¼ wave length design
- Top loaded coil
- 27 MHz
- Chrome plated adapter
- Fits all 3/8 x 24 threaded mounts
- Mil-Spec Polyolefin sheath
- Copper magnet wire
- Can be use as single antenna or co-phased
- Available with heavy duty aluminum 3-way mirror mounts and 12 feet of RG-58 coax with dual PL-259 connectors
- Co-phased system consists of two heavy duty aluminum 3-way mirror mounts, 18 foot co-phasing harness with three PL-259 connectors
- Available in 3 foot or 4 foot length
- Colors Black, White and Red

- F-3 3 foot stick only
- F-60 3 foot stick includes mirror mount and cable
- F-61 Dual 3 foot stick includes two mirror mounts and co-phased harness
- F-4 4 foot stick only
- F-62 4 foot stick includes mirror mount and cable
- F-63 Dual 4 foot stick includes two mirror mounts and co-phased harness



Toll Free Order Line (877)994-9499



# CENTER LOAD ANTENNAS

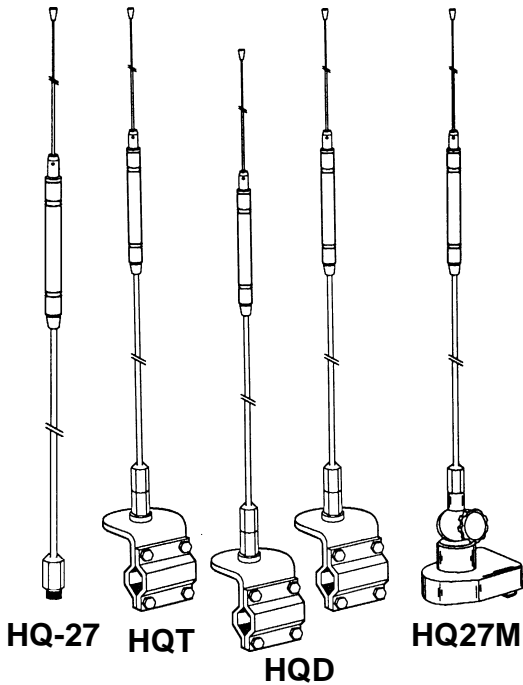

After 20 years of proven performance, the HQ remains one of the most popular CB antennas on the market. Hustler narrow coil design allow the antenna to disappear into the vehicle. Our longest center loaded antenna moves the coil above the cab to achieve maximum radiation patterns.

- 27 MHz Frequency
- Computer designed for a narrow efficient coil
- ¼ wavelength design
- Adjustable whip length for accurate tuning
- Chrome plated top and bottom fittings
- Stainless steel 17-7 ph whip
- Dissipation tip to eliminate static build up
- Solid stainless steel lower rod
- Used as a single antenna, co-phased for dual application or trunk mount with swivel ball
- Available with heavy duty aluminum 3-way mirror mounts and 12 foot of RG-58 coax with dual PL-259 connectors
- Co-phased system consists of two heavy duty aluminum 3-way mirror mounts, 18 foot co-phasing harness with three PL-259 connectors
- Available with trunk mount, features swivel ball for proper vertical polarization, 15 foot of RG-58 coax with PL-259 connector
- Mil-Spec Polyolefin white sheath
- Mates with 3/8 x 24 threaded mounts

- HQ-27** 55 inches tall mounts on 3/8 x 24 base
- HQ-27B** 55 inches tall mounts on 3/8 x 24 base black sheath
- HQT** 55 inches tall includes mirror mount and coax
- HQD** Dual HQT includes mirror mount and co-phase harness
- HQ27M** Trunk mount version of HQ-27 w/swivel ball, coax and connector.

## CENTER LOAD

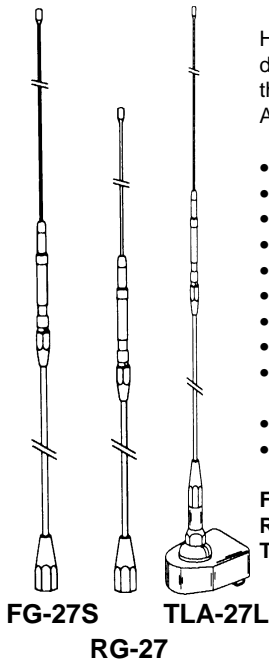

Hustler thinnest designed coil allowing the antenna to disappear on any vehicle. Computer designed to offer the compromise between size and performance. Available in two lengths to fit your application needs.

- 27 MHz Frequency
- Computer designed for a narrow efficient coil
- ¼ wavelength design
- Adjustable whip length for accurate tuning
- Chrome plated top and bottom fittings
- Stainless steel 17-7 ph whip
- Dissipation tip to eliminate static build up
- Solid stainless steel lower rod
- Used as a single antenna, co-phased for dual application
- Mil-Spec Polyolefin white sheath
- Mates with 3/8 x 24 threaded mounts

- FG-27S** 48 inches long
- RG-27** 36 inches long
- TLA-27LS** Trunk mount, 49" long, 15 feet RG58 coax PL-259 connector

## STAINLESS STEEL WHIP



Hustler's 102 inch whip antenna is made from the finest 17-7 ph tapered stainless steel which resists bending and kinking. This material is so tough it can be bent 180 degrees and will spring back to its original shape. Excellent for all off-road terrain. Dissipation tip to reduce unwanted static buildup. Fits all 3/8 x 24 threaded mounts.

- 1C-56** 102 inch stainless steel whip

**1C-56**



Toll Free Order Line (877)994-9499



# SHORT CENTER LOAD ANTENNAS

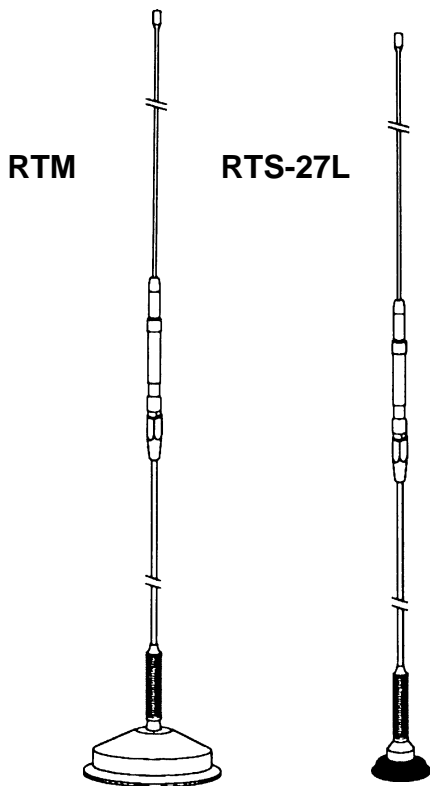

Hustler's shortest center load antenna on the market. Fits that need where height is a restriction, but center load performance is still needed. The center load coil is tailored after the popular FG-27 antenna.

- 27 MHz Frequency
- Computer designed for a narrow efficient coil
- ¼ wavelength design
- Adjustable whip length for accurate tuning
- Chrome plated top and bottom fittings
- Stainless steel 17-7 ph whip
- Dissipation tip to eliminate static build up
- Solid stainless steel lower rod
- Mil-Spec Polyolefin white sheath
- Stainless steel spring
- Available as a roof mount (3/4 inch hole) and magnet mount
- Includes RG58 coax with PL-259 connector

**RTM** 25 inches tall magnet mount and 15 feet of RG58 coax  
**RTS-27L** 25 inches tall roof mount with 12 feet of RG58 coax

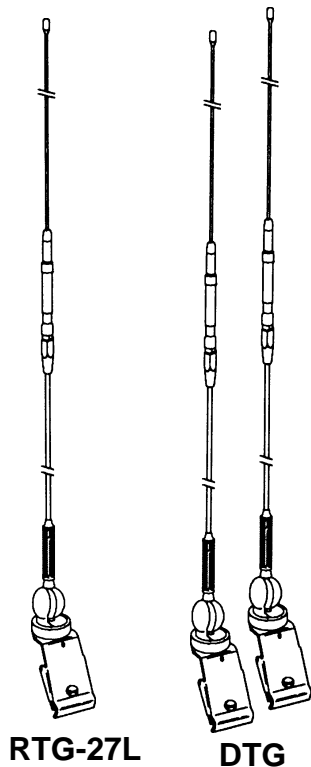

Hustler's short center load used where height is a restriction. The Stainless steel clamp resists corrosion with a chrome plated swivel ball to insure proper vertical positioning. This center load coil is tailored after the popular FG-27s antenna.

- 27 MHz Frequency
- Computer designed for a narrow efficient coil
- ¼ wavelength design
- Adjustable whip length for accurate tuning
- Chrome plated top and bottom fittings
- Stainless steel 17-7 ph whip
- Dissipation tip to eliminate static build up
- Solid stainless steel lower rod
- Mil-Spec Polyolefin white sheath
- Stainless steel spring
- Stainless steel clamp
- Chrome plated swivel ball
- RTG-27L includes 12 ft RG58 coax with PL-259 connector
- DTG includes 12 ft co-phase harness with PL-259 connector

**RTG-27L** 25 inches tall, clamp mount, 12 feet of RG58 coax  
**DTG** Dual 25 inches tall, clamp mount and co-phase harness

# SPRINGS AND MOUNTS

**SSM-1**



- Heavy-duty ball and spring mount
- 4" stainless steel spring
- Copper braided center conductor to prevent detuning
- 180 degree adjustable 2" diameter stainless steel ball
- Exclusive "C" backup plate for installation on sealed fender wells
- Includes cork pad and mounting hardware
- Accepts 3/8" x 24 antennas

**SSM-1** Spring, ball and mount

**SSM-2**



- Heavy-duty 2" diameter stainless steel ball mount
- 180 degree adjustable
- 3 1/2 inch base plate
- Exclusive "C" backup plate for installation on sealed fender wells
- Includes cork pad and mounting hardware
- Accepts 3/8" x 24 antennas

**SSM-2** Ball mount

**SSM-3**



- Heavy-duty stainless steel
- 4" spring with 3/8" x 24 coupling stud
- Copper braided center conductor to prevent detuning
- Protective spring caps
- Exclusive Hex nut tightening system
- Accepts 3/8" x 24 antennas

**SSM-3** Stainless steel spring

**1C-53**

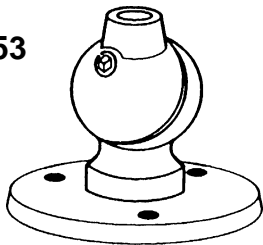

- Heavy-duty 2 inch diameter chrome plated ball mount
- 180 degree adjustable
- 3 1/2 inch base plate
- Includes rubber pad and steel backup plate
- Mounting hardware and hex key
- Accepts 3/8" x 24 antennas

**1C-53** Ball mount

**C-32**



- Heavy-duty 1 1/2" diameter chrome plated ball mount
- 180 degree adjustable
- 2 3/4 inch base mount
- Includes rubber pad and steel backup plate
- Mounting hardware and hex key
- Accepts 3/8" x 24 antennas

**C-32** Ball mount

**QD-2**



- 100% Stainless Steel
- Remove antenna from mount in seconds with push and twist release
- Every part including the compression spring is manufactured from the best available 100% stainless steel
- Special design of enclosed compression and lock assembly prevents ice and dirt jam up
- Accommodates small, medium and large mobile antennas
- Equipped with 3/8" x 24 threads, female on one end and male on the other

**QD-2** Quick Disconnect

# SPRINGS AND MOUNTS

**C-30**



- Heavy-duty Chrome plated spring
- 4" spring with 3/8" x 24 coupling stud
- Copper braided center conductor to prevent detuning
- Accepts 3/8" x 24 antennas

**C-30** Chrome plated spring

**C-29**



- Heavy-duty stainless steel spring
- 4" spring with 3/8" x 24 coupling stud
- Copper braided center conductor to prevent detuning
- Accepts 3/8" x 24 antennas

**C-29** Stainless steel spring

**RSS-2**



- 3 inch Stainless spring
- Used between resonators and mast
- Accepts 3/8 x 24 threaded antennas
- Female threads on one end male on other
- Copper braided center conductor to prevent detuning
- Absorbs shock when antenna strikes overhanging objects

**RSS-2** Stainless steel resonator spring

**D-321**

**D-322**

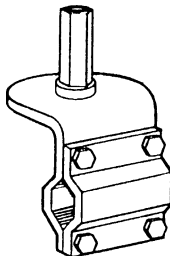

- Three way mirror mount
- Mounting for bars, rails or mirror arm
- Non-corrosive heavy duty aluminum
- Use without clamp for side mount applications
- Four bolt application
- Hardware included
- Standard stud 3/8 x 24 thread or SO-239

**D-321** Mirror mount with standard stud

**D-322** Mirror mount with SO-239

**D-301**

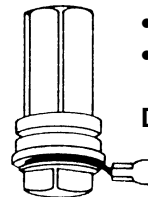

- Chrome plated 3/8 x 24 thread stud
- For mounts with 1/2 inch holes
- Crimp on lug connections

**D-301** Standard stud

**D-302**

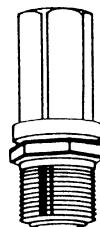

- Chrome plated 3/8 x 24 thread stud
- For mounts with 1/2 inch holes
- Screw on SO-239 (accepts PL-259)

**D-302** SO-239

# MOUNTS 3/8 x 24

## HOT

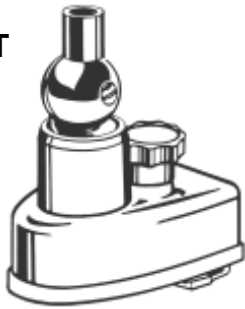

- Trunk lip mount
- Easy antenna on/off by spinning knob
- Cannot be removed while trunk is closed
- Designed for trunk deck, hatch or slanted back vehicle
- 180 degrees adjustable swivel for vertical positioning
- 1 inch chrome plated swivel ball
- No holes required to install
- Rubber gasket to protect deck lip
- Accepts 3/8 x 24 threaded antennas
- 15 feet of RG58 low loss coax with PL-259 connector

**HOT** Trunk lip mount

## HLM

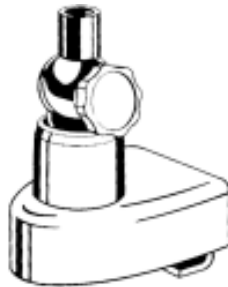

- Trunk lip mount
- Designed for trunk deck, hatch or slanted back vehicles
- 180 degrees adjustable swivel
- 1 inch chrome plated swivel ball
- Accepts 3/8 x 24 threaded antennas
- 15 feet of RG58 low loss coax with PL-259 connector

**HLM** Trunk lip mount with swivel

## TLM

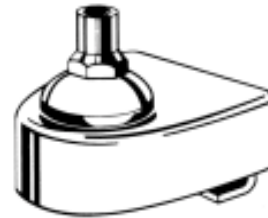

- Trunk lip mount
- Designed for trunk deck
- No holes required to install
- Accepts 3/8 x 24 threaded antennas
- 15 feet of RG58 low loss coax with PL-259 connector

**TLM** Trunk lip mount

## RVM



- Durable, heavy duty mount for vertical side panel or roof mounting
- Rugged design features a 180 degree swivel for optimum vertical positioning
- Quick repositioning antenna with thumb knob
- 17 feet RG58 coax with crimp on lugs and PL-259 connectors
- Includes grommet and mounting hardware
- Accepts 3/8 x 24 threaded antennas

**RVM** Vertical side mount

## BM-1



- Heavy-duty stainless steel strap fits bumpers to 18" vertical height
- Secured by two heavy "J" bolts
- 180 degrees adjustable swivel for vertical positioning
- 2 inch chrome plated swivel ball
- Accepts 3/8 x 24 threaded antennas
- All hardware included

**BM-1** Strap mount

## GCM-1

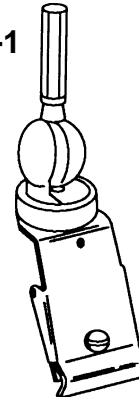

- Deluxe, heavy gauge stainless steel mount
- Completely adjustable with 180 degree swivel
- 1 inch chrome plated swivel ball
- Accepts 3/8 x 24 threaded antennas

**GCM-1** Clamp mount

# MAGNETIC MOUNT

**MBM**



- 95 lbs pull strength
- Powerful 5 inch diameter magnet
- 8 pole magnet
- 18 feet RG58 coax with PL-259 connector
- Accepts 3/8 x 24 threaded antennas
- Recommended for antennas up to 48"

**MBM** Magnet mount

# MOBILE ANTENNA

**1C-20** Hustler's full feature roof or deck mount antenna. Includes chrome fittings, a polished stainless steel impact spring and a tapered whip. Perfect for where permanent installation is required. Requires 3/8 inch hole. Stands only 44 inches tall. Includes 12 feet of coax with PL-259 connector.

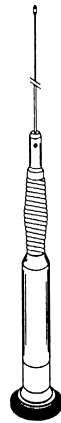

- 17-7 ph tapered stainless steel whip
- Easy to tune
- 12 feet of coax with PL-259 connector
- Chrome plated whip adapter
- For 27 MHz CB
- High impact plastic housing
- Rugged construction
- Includes rubber weather gasket

**1C-20** Roof mount with coax and connector, available in black or white

**1C-75**

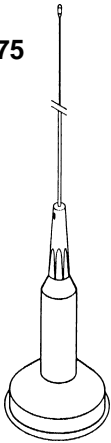

Hustler's small diameter Magnetic mount which still offers reliable tuning, solid performance and quality construction. A one-piece high impact plastic housing covers the coil and small diameter magnet. 43 inches tall, includes 15 feet of coax with PL-259 connector. Perfect for multi car families and leased or rented vehicles. Available in black or white color.

- 17-7 ph tapered stainless steel whip
- Easy to tune
- 15 feet of coax with PL-259 connector
- Chrome plated whip adapter
- For 27 MHz CB
- High impact plastic housing
- One piece construction
- Easy on and off with small diameter magnet

**1C-75** Magnetic mount with coax and connector, available in black or white

# BASE STATION

**G-2537**  
**G-3754**

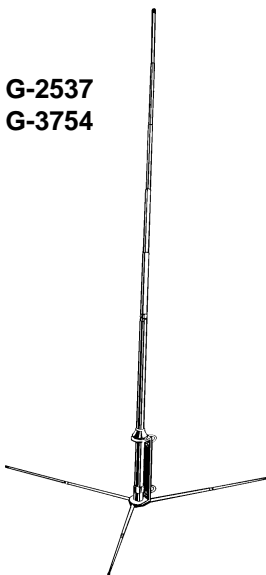

Hustlers **G Series** omnidirectional antennas are the perfect choice where durability and performance are the priority. Made of high strength aluminum and fiberglass the G Series can handle the harshest environments. Shunt fed-direct ground, which reduces lightning exposure and static buildup.

- Tunable from 25-37 or 37-54 MHz
- End-fed collinear
- Bandwidth: 1 MHz
- Construction: High strength aluminum
- Wavelength: .64
- Watts: 300
- Sealed impedance transformer, shunt fed

**G-2537** 25-37 MHz fix station  
**G-3754** 37-54 MHz fix station



Toll Free Order Line (877)994-9499





# MOBILE ANTENNAS

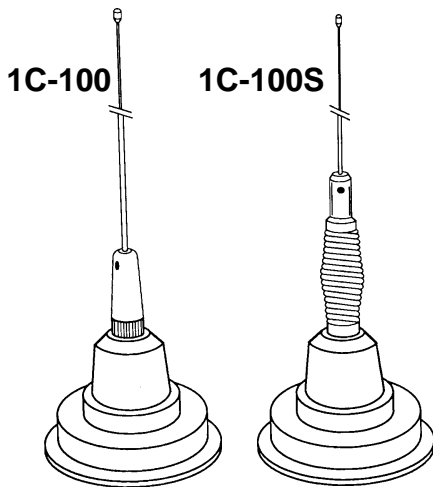

Magnetic mount offering reliable tuning, solid performance and quality construction. A one-piece high impact plastic housing covers the coil and powerful magnet. 41 inches tall, includes 15 feet of coax with PL-259 connector. Perfect for multi car families and leased or rented vehicles. Available in black or white color with or without shock resistant impact spring.

- 17-7 ph tapered stainless steel whip
- Easy to tune
- 15 feet of coax with PL-259 connector
- Chrome plated whip adapter
- For 27 MHz CB
- High impact plastic housing available in black or white

**1C-100** Magnetic mount with coax, connector

**1C-100S** Same as 1C-100 but includes shock resistant impact spring

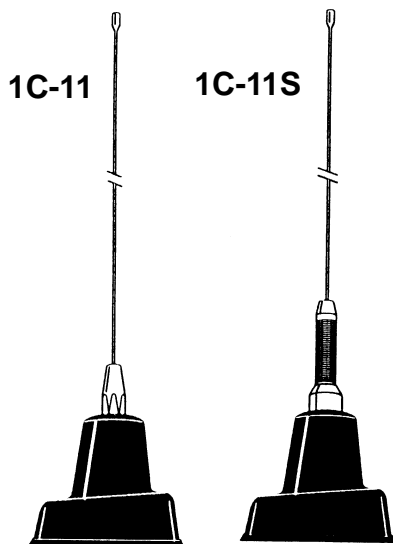

Our traditional one piece trunk lip mount. A one-piece high impact plastic housing covers the coil and trunk lip bracket. Chrome plated whip adapter or stainless steel impact spring. 42 inches tall, includes 16 feet of coax with PL-259 connector.

- 17-7 ph tapered stainless steel whip
- Easy to tune
- 16 feet of coax with PL-259 connector
- Chrome plated whip adapter or stainless steel impact spring
- For 27 MHz CB
- High impact plastic housing available in black or white
- One piece trunk lip design

**1C-11** Trunk lip mount with chrome adapter, coax and connector

**1C-11S** Trunk lip mount with stainless steel spring, coax and connector

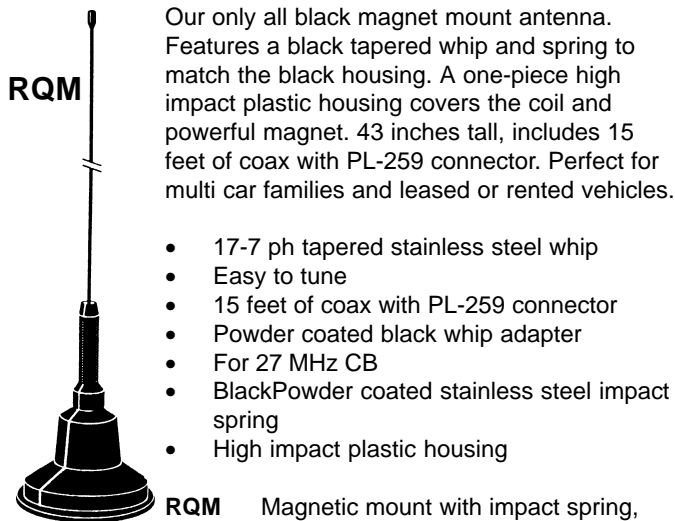

Our only all black magnet mount antenna. Features a black tapered whip and spring to match the black housing. A one-piece high impact plastic housing covers the coil and powerful magnet. 43 inches tall, includes 15 feet of coax with PL-259 connector. Perfect for multi car families and leased or rented vehicles.

- 17-7 ph tapered stainless steel whip
- Easy to tune
- 15 feet of coax with PL-259 connector
- Powder coated black whip adapter
- For 27 MHz CB
- Black Powder coated stainless steel impact spring
- High impact plastic housing

**RQM** Magnetic mount with impact spring, coax and connector

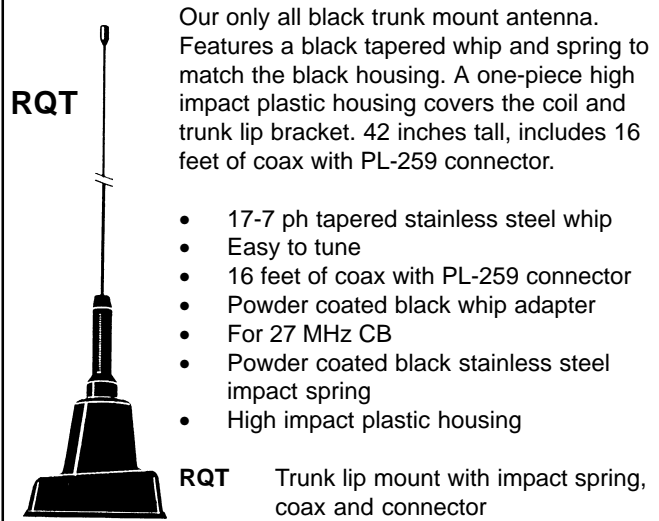

Our only all black trunk mount antenna. Features a black tapered whip and spring to match the black housing. A one-piece high impact plastic housing covers the coil and trunk lip bracket. 42 inches tall, includes 16 feet of coax with PL-259 connector.

- 17-7 ph tapered stainless steel whip
- Easy to tune
- 16 feet of coax with PL-259 connector
- Powder coated black whip adapter
- For 27 MHz CB
- Powder coated black stainless steel impact spring
- High impact plastic housing

**RQT** Trunk lip mount with impact spring, coax and connector

# SCANNER MOBILE ANTENNAS

Hustler's Mobile scanner antennas allow you to stay tuned in while being on the road. 40 – 950 MHz frequency range. Factory tuned so no tuning necessary. Receives all Scanner bands, Low band, High band, UHF public service, VHF/UHF TV, 88-108 FM radio and Amateur radio.

## MRM



- 3 oz Magnet mount
- 12 ft RG58 coax
- Available with BNC or Pin Plug connector

**MRM** Magnet mount mobile scanner antenna

## MOT



- Trunk mount
- 15 ft RG58 coax
- Available with BNC or Pin Plug connector

**MOT** Trunk mount mobile scanner antenna

## MOR



- 3/4" Roof or deck mount
- 12 ft RG58 coax
- Available with BNC or Pin Plug connector

**MOR** Roof mount mobile scanner antenna

## MOG

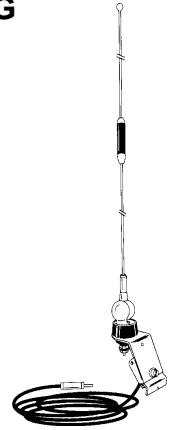

- Clip mount
- 12 ft RG58 coax
- Available with BNC or Pin Plug connector

**MOG** Clip mount mobile scanner antenna

# SCANNER BASE STATION

## Scanner Base Station Antenna

Hear more at a greater distance with Hustler's external omnidirectional scanner antennas

- 40 – 950 MHz Factory tuned Discone
- Receives Low band, High band, UHF public service, VHF/UHF TV, 88-108 FM radio and Amateur radio
- Vertically Polarized
- Mounts to 1 1/4" OD mast or flat surface
- 55" cone elements
- 20" disc elements
- Solid aluminum rod for high strength design
- Hardware and mount included

**DCX** Scanner base station antenna

DCL is the same as DCX but includes 50 ft of RG58 coax with PL-259 on one end and BNC or Pin Plug on the other end

**DCL** Scanner Base Station with cable

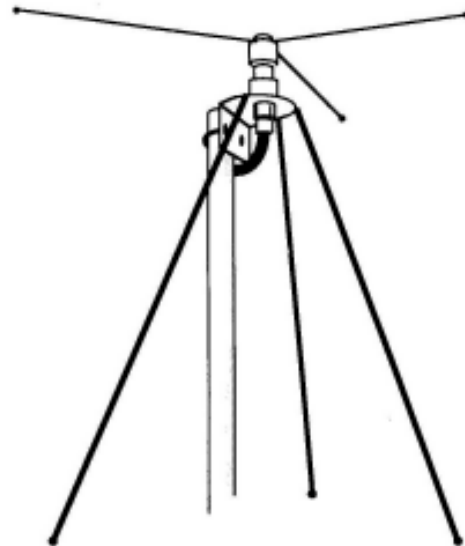

Toll Free Order Line (877)994-9499



# 800 MHz ANTENNAS

## CMT Series

- 3 oz magnetic mount
- Gain: 3.2 dB
- Bandwidth: 100 MHz @2:1
- 5/8 wavelength
- Black polyester powder coating
- Stainless steel radiator
- 12 ft RG58/U coax with Mini-UHF or TNC connector

### Model Connector

CMT-800 TNC  
CMT-800M Mini UHF

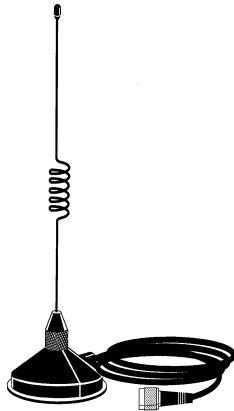

## MC Series

- 1 oz magnetic mount
- Gain: 3.5 dB
- Bandwidth: 100 MHz @2:1
- 5/8 wavelength
- Black polyester powder coating
- Stainless steel radiator
- 10 ft RG-174 coax with Mini-UHF, TNC, Ericsson or Nokia connector

### Model Connector

MC-800 TNC  
MC-800-M Mini UHF  
MC-800-N2 Nokia 2100  
MC-800-N6 Nokia 5100 & 6100  
MC800-E Ericsson 200, 300 & 600  
MC-800-E7 Ericsson 700

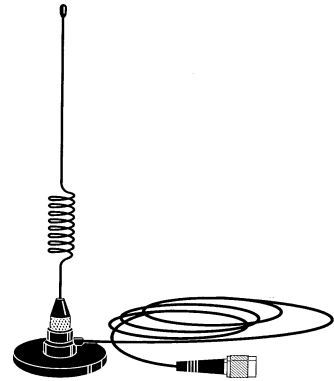

## CPA cables series

Adapts your cellular phone with CMT800, MC800 or Yagi antennas. Comes complete with your choice of connectors and 7 ft RG-174U coax and connectors

### Model Connector

CPA-N2M Mini UHF & Nokia 2100  
CPA-N6M Mini UHF & Nokia 5100, 6100  
CPA-EM Mini UHF & Ericsson 200, 300, 600  
CPA-E7M Mini UHF & Ericsson 738, 788

### Model Connector

CPA-N2T TNC & Nokia 2100  
CPA-N6T TNC Nokia 5100, 6100  
CPA-ET TNC & Ericsson 200, 300, 600  
CPA-E7T TNC & Ericsson 738, 788

# YAGI 800/900 MHz ANTENNAS

## YU Yagi Series

- Environment: Standard - U channel design welded from the inside to enhance electrical performance
- Freq. Range: 806-960
- Power rating: 500 watts
- Polarization: Vertical
- Vertical Beamwidth: 40 degrees
- Horizontal Beamwidth: 55 degrees
- Lightning protection: Direct ground
- Connector: TNC pigtail
- Stainless steel hardware
- All aluminum welded and sealed electrical components prevents intermodulation and corrosion

### Model MHz

YU10-80669 806-869  
YU10-82496 824-896  
YU10-89060 890-960

### Yagi Cable

COAX 8240-20 20 ft RG58/U coax for yagi antenna w/ female Mini and Male TNC  
COAX 8240-50 50 ft RG58/U coax for yagi antenna w/ female Mini and Male TNC

## YG Yagi Series

- Environment: Harsh-Heavy tubular wall aluminum O-ring construction seals out moisture & prevents intermodulation
- Freq. Range: 806-960
- Power rating: 500 watts
- Polarization: Vertical
- Vertical Beamwidth: 40 degrees
- Horizontal Beamwidth: 55 degrees
- Lightning protection: Direct ground
- Connector: "N" connector
- Stainless steel hardware
- All aluminum welded and sealed electrical components prevents intermodulation and corrosion

### Model MHz

YG10-80669 806-869  
YG10-82496 824-896  
YG10-89060 890-960

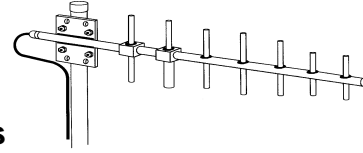
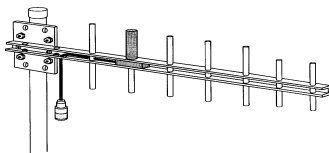

Toll Free Order Line (877)994-9499

